

RAIDON

SafeTANK
GR3660-TB3
User Manual

» GR3660-TB3 User Manual	1
1. Operating Information	1
2. Package Contents and Product Views	1
3. Hardware Requirements and Precautions	2
4. Hardware Installation.....	3
5. RAID Modes and How to Switch between the RAID Modes	4
6. The Indication of HDD Status	5
7. Connect with other devices	5
8. Common Technical Questions.....	6
» GR3660-TB3 產品使用說明.....	8
1. 環境需求	8
2. 產品外觀及包裝內容	8
3. 硬體需求與注意事項	9
4. 硬體安裝	10
5. RAID 設定	11
6. 硬碟狀態指示燈號說明	11
7. 與其他裝置連接說明	12
8. 常見問題	13

The Introduction

Thanks for purchasing RAIDON product. This User Manual will introduce you the GR3660-TB3 Thunderbolt™ storage product. Before using your GR3660-TB3, please read it thoroughly. Although all information contented in this User manual had already been carefully verified before publishing, however, the actual product and its specification will be based upon the time of delivery from RAIDON. Any update to the product or its relevant information may be listed on www.RAIDON.com.tw. Product is subjected to change without prior notifications.

If you have any question regarding to the product you purchased, or you would like to know the latest product information, User Manual's update, please contact to your local supplier or visit to www.RAIDON.com.tw for further information.

Copyright © Raidon Technology, Inc. – All right is reserved.

1. Operating Information

Operating Temperature: 0 ~ 40 °C (32 ~ 104 °F)

Storage Temperature : -20 ~ 47°C (-4 ~ 116 °F)

Line Voltage : 100 ~ 240V AC

2. Package Contents and Product Views

Open the package and you shall find the following parts :

GR3660-TB3
GR3660-TB3 Product Unit x1 (Removable Tray x2)
Thunderbolt™ Cable x1
Power Cord x1
AC/DC Adapter x1
Screws and key
Quick Installation Guide x1

- Please check the product and accessories for any defect or missing parts. If you have any questions, please contact your product supplier.
- Please visit the official website - Download page (<http://www.RAIDON.com.tw/RAIDON2016/download.php>) to download drivers and other related resources.

Front and Rear Views

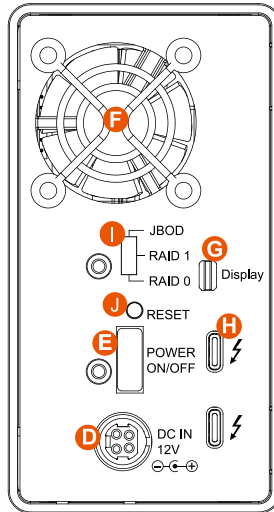
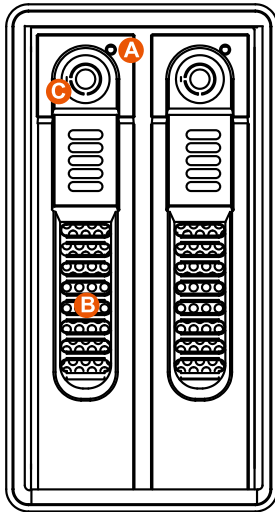

- A. HDD access Indicator
- B. Removable drive tray
- C. HDD tray key lock
- D. Power socket
- E. Power switch
- F. Fan
- G. Mini DisplayPort
- H. Thunderbolt™ port
- I. Port RAID Dip-switch
- J. Reset Button

3. Hardware Requirements and Precautions

1. Since GR3660-TB3 will delete all data files in your two HDDs/SSDs at its first-time use, please be informed that you shall first save all your personal data files into a safe memory space before starting setting your new GR3660-TB3 to avoid any data loss during your start-up process.
2. Please make sure that the hard drives are free from bad blocks or defects prior to installation in order to avoid system crashes or data loss.
3. Whenever turning off or unplugging your GR3660-TB3 from your computer system, please always remember to safely remove it from your operating system first.
4. When your GR3660-TB3 connects to the computer system, please do not remove, insert or even swap any hard drive while data transfer is being performed.
5. A WARNING to you if you plan to delete or switch your original RAID setting: If you plan to delete or switch your original RAID setting, please always duplicate your personal data before deleting or changing it.
6. GR3660-TB3 uses a 12V/5V AC/DC Adapter. Please do not use other non-certified Power Adapter to avoid damaging to your GR3660-TB3.
7. We strongly recommend you to keep an extra copy at your important personal data other than stored in your GR3660-TB3 product. RAIDON will not be responsible of your data loss problem.

4. Hardware Installation

Please follow the instructions below to complete the hardware installation.

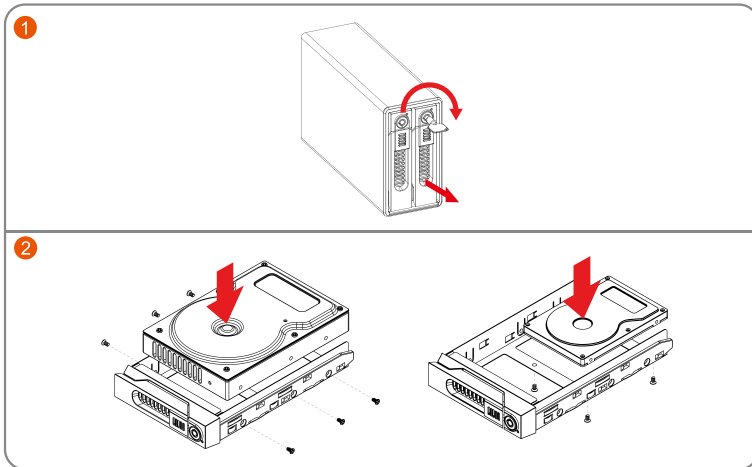

- Step 1 Use the provided key in the Accessories Kit and inserted it into the Key Access Opening to eject the Removable Drive Tray Latch and extract the Removable Drive Tray.
- Step 2 Mount your hard drives onto the removable drive tray and secure it with the screws included in the accessory kit to avoid any damage to the hard drive due to accidental movements.
- Step 3 After installing two HDDs into Trays, please insert them into GR3660-TB3, and then latch the handle.
- Step 4 Please switch RAID Dip-switch to JBOD mode at back-plate.
- Step 5 Please connect the Thunderbolt™ Cable, and then connect AC/DC Adapter to the product.
- Step 6 Please turn on power.
- Step 7
 - a. After turning on power, the HDD/SSD Indicator will be changed with the following sequence, Red > Off > Blue, and then, GR3660-TB3 is ready for use.
 - b. In case if the HDD/SSD Indicator shows Red > Off > Blue Flashing, please use a pin to press the RESET Button for 3 seconds, and wait until the HDD/SSD Indicator is changed to Blue from Blue Flashing, your GR3660-TB3 is then ready for use.
- Step 8 While your ST2-T3B is ready for use, please follow the instruction of "F. The Standard Procedure to Switch RAID Setting" in Chapter 5 and set the RAID mode to what you want. You could then start using your GR3660-TB3 now.

5. RAID Modes and How to Switch between the RAID Modes

- A. Please clear the RAID setting and format your two used HDDs before starting using your new GR3660-TB3.
- B. Please keep a copy of all your personal data into a safe storage space before you set RAID mode at your GR3660-TB3 unit.
- C. JBOD (Factory defaults): Two independent storage volumes with no data protection feature.
- D. RAID-1:
One independent data storage with data protection feature.
Other features:
- RAID 1 data protection feature is to duplicate all your personal data into the second HDD, and GR3660-TB3 could still work in case if one of the HDDs becomes defect.
** GR3660-TB3 won't help data protection if anyone of the two HDDs is out of working.
 - If you use two different memory size HDDs, GR3660-TB3 will only use the maximum memory capacity up to the small HDD one.
** For example: if your two HDDs are with 1TB & 2TB memory capacity each, GR3660-TB3's maximum memory will be up to 1TB.
- E. RAID-0: One big independent a storage with accelerated data transfer rate but with no data protection feature.
- F. The Standard Procedure to Switch RAID Setting
- Step-1: Please first connect GR3660-TB3 to your Mac.
- Step-2: Please set RAID Dip Switch to the position you choose.
- Step-3: Please use the Key to press the hidden RESET key at the back-plate, hold and wait for the end of Blue-Purple LED blinking till a stable Blue light.
- Step-4: Please turn off your GR3660-TB3, and re-turn it on again. You now have reset GR3660-TB3 with a new RAID mode successfully.

A WARNING to you if you plan to delete or switch your original RAID setting :
If you plan to delete or switch your original RAID setting, please always duplicate your personal data before deleting or changing it.

6. The Indication of HDD Status

Status	LED Light Status
No HDD	Red light always on
HDD failed	Red light always on
HDD idle	Blue light always on
Data access	Blue light flashing
Rebuilding, Source HDD	Breathing blue light
Rebuilding, Target HDD	Breathing purple light

7. Connect with other devices

1. TB port: Thunderbolt™ 3 ports can be connected to TB3, USB3.1 and Display port device. It is downward to support USB3.0 / USB2.0. This product can connect with different USB devices by USB Type C to Type A/B cable. It supports TB port power delivery (PD) function, which can provide 15W (5V / 3A) power output to support 5V / 3A rechargeable notebook computer use. There is no additional power supply need.
2. Mini Display port: configured with Mini Display Port connection port to provide additional screen output.

Two System Connections:

- A. GR3660-TB3: Let its TB A port connect to Host (PC/Workstation/Server), TB B port to other Device (USB or TB), and mDP (Mini Display) port to monitor.

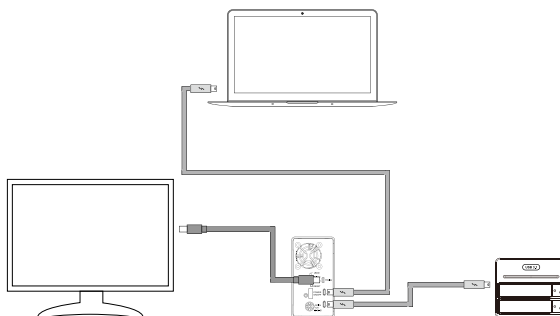

- B. GR3660-TB3: Let its TB A port connect to Host (PC/Workstation/Server), TB B port to a monitor, and mDP port to the second monitor.

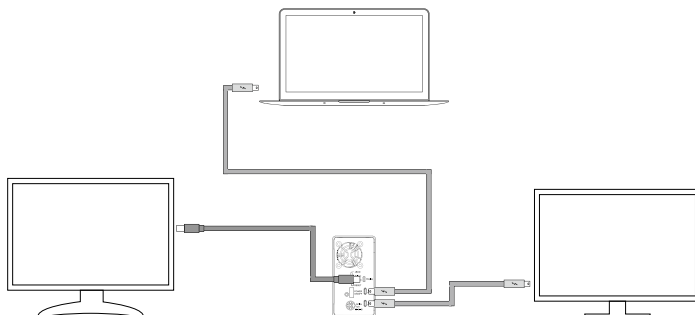

8. Common Technical Questions

- GR3660-TB3 will always stay SLEEP Mode if (a) it doesn't connect it to Mac Computer, and (b) your Mac Computer is Power-Off.
- GR3660-TB3 will also stay SLEEP Mode if your Mac Computer gets into SLEEP or IDLE Mode too.
- In case if you use two old HDDs which already have other RAID setting, we would strongly suggest you to first reset them with JBOD mode at your GR3660-TB3 before setting them to the RAID mode you will use GR3660-TB3.
- If the computer is unable to detect the system, please install the drivers from official website - Download page (<http://www.RAIDON.com.tw/RAIDON2016/download.php>) .
- If the GR3660-TB3 is installed on the Windows OS but can not be connected, refer to the following steps:
 - Open the Windows Taskbar.
 - right-click the Thunderbolt™ icon.
 - Select "Approve Attached Devices".
 - Select the port to which the device is connected.
 - Wait for the dialog box "Approve Thunderbolt™™ Devices" to appear.
 - Select "Always Connect"
 - Press "OK" °

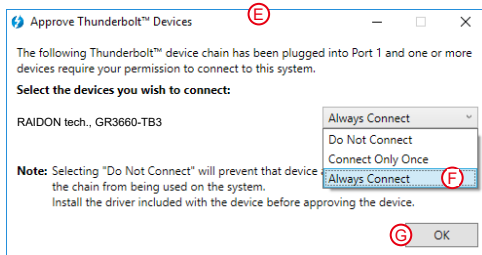
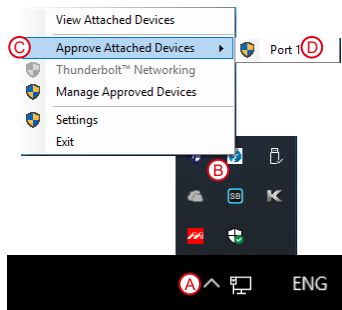

6. The new macOS 10.13 (High Sierra) requires user approval before loading new, third-party kernel extensions:
 - A. Execute **MarvellMvumi.pkg**.
 - B. Appear from an unidentified developer warning, click on the lower right corner of the "OK."
 - C. Open **System Preferences**, and go to **Security & Privacy**.
 - D. Click on the "Allow" button.

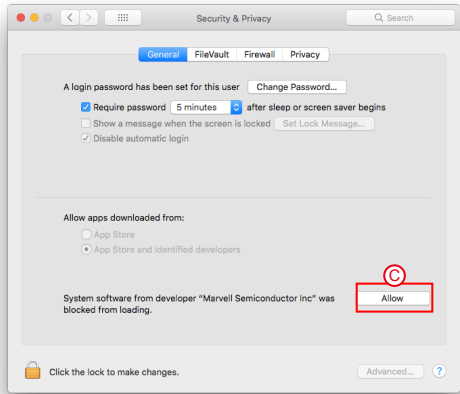
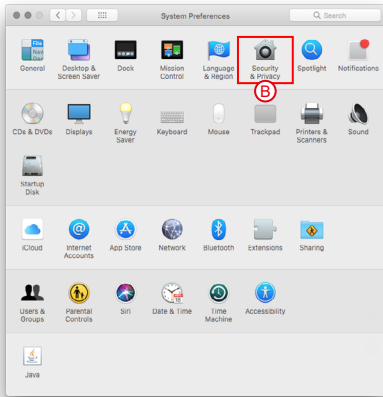

Note: If you can not click the allow button, click the lower left corner of the lock icon, and enter the administrator password.

關於這份手冊

感謝您使用 RAIDON 的產品。本手冊將介紹 RAIDON GR3660-TB3 產品。在您開始使用 RAIDON GR3660-TB3 產品前，建議您先閱讀過本手冊。手冊裡的資訊在出版前雖已被詳細確認，實際產品規格仍將以出貨時為準；任何產品規格或相關資訊更新請您直接到 www.RAIDON.com.tw 網站查詢，本公司將不另行通知。若您想獲得 RAIDON 最新產品訊息、使用手冊、韌體，或對 RAIDON 產品有任何疑問，請您聯絡當地供應商或到 www.RAIDON.com.tw 取得相關訊息。

本手冊相關產品內容歸銳銳科技股份有限公司版權所有

1. 環境需求

工作溫度：0 ~ 40 °C (32 ~ 104 °F)

儲存溫度：-20 ~ 47 °C (-4 ~ 116 °F)

工作電壓：100 ~ 240V AC

2. 產品外觀及包裝內容

打開包裝外盒後，包裝內容應包含下列組件：

GR3660-TB3
GR3660-TB3 產品本體 x1(內含抽取盒 x2)
Thunderbolt™ 連接線 x1
電源線 x1
電源轉換器 x1
螺絲及鑰匙
快速安裝手冊 x1

- 請確認相關配件與產品本身是否有受損或配件缺少，若有任何疑問請與本產品供應商聯絡。
- 請前往官網 - 產品資料下載頁面 (<http://www.raidon.com.tw/RAIDON2016/download.php>) 下載驅動程式以及其餘相關資源。

正面與背面示意圖

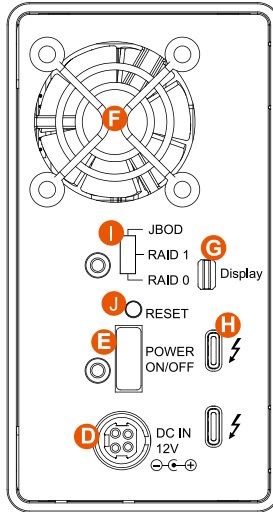
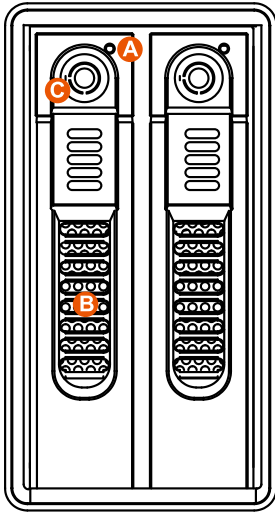

- A. 硬碟讀取燈
- B. 硬碟抽取盒把手
- C. 硬碟抽取盒鑰匙孔
- D. 電源插座
- E. 電源開關
- F. 風扇
- G. Mini DisplayPort
- H. Thunderbolt™ 連接埠
- I. RAID 切換鈕
- J. RESET 按鈕

3. 硬體需求與注意事項

1. 第一次使用本產品進行設定時，資料會被全數清除。請於硬碟置入前，確認硬碟已備份，避免資料遺失。
2. 在安裝新硬碟到 GR3660-TB3 之前，請先確認硬碟是沒有壞軌而且是沒有故障的，以避免資料受損。
3. 當您需要關閉或移除 GR3660-TB3 時，務必透過您所操作的作業系統中執行硬碟安全移除後，方可進行電源關閉的動作。
4. 當系統運作時，請勿任意移除任何一顆硬碟，以免導致資料遺失。
5. RAID 模式一旦設定完成，若要進行切換，因切換過程中將會清除硬碟中的資料，請務必先將硬碟中的資料另行備份後再行切換。
6. GR3660-TB3 使用 12V/5A 規格 Adapter，請勿使用其他非原廠規格 Adapter 以免損壞機器及資料。
7. 強烈建議除了使用 GR3660-TB3 的資料儲存功能外，請針對重要資料備份到另一個儲存裝置上或遠端備份，雙重備份您重要的資料。若您儲存在 GR3660-TB3 的資料損毀或遺失，RAIDON 將不負任何的責任。

4. 硬體安裝

請參照以下步驟完成硬體安裝

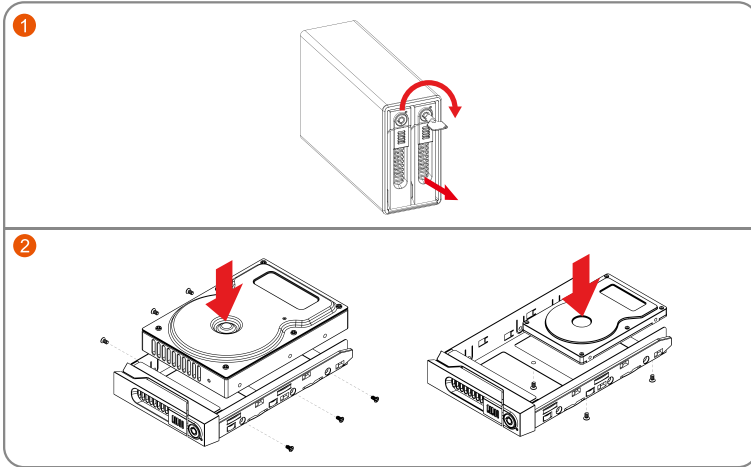

- 步驟 1 請使用零件包內附的鑰匙插入鑰匙孔後，抽取盒門門將會輕彈開啟，即可將硬碟機抽取盒取出。
- 步驟 2 將硬碟安裝到抽取盒上，並以零件包內附的螺絲加以固定，以避免不必要的移動對硬碟造成傷害。
- 步驟 3 硬碟安裝完成後，請將抽取盒平移放入主機內，並關上把手。
- 步驟 4 將硬碟安裝到抽取盒上，並以零件包內附的螺絲加以固定，以避免不必要的移動對硬碟造成傷害。
- 步驟 5 將相關連接線接上，最後接上電源轉接器。
- 步驟 6 將機體背面的電源開關打開。
- 步驟 7
- 機器啟動後，抽取盒燈號會由「紅燈恆亮 > 熄滅 > 藍燈恆亮」燈號，即為完成機器安裝設定。
 - 如機器啟動後，抽取盒燈號如出現「紅燈恆亮 > 熄滅 > 藍紫閃爍」燈號，請使用頂針插入「重置鍵」3 秒後鬆開頂針，待燈號由「藍紫閃爍」燈號轉變為「藍燈恆亮」燈號時，即為完成機器安裝設定。
- 步驟 8 機器安裝設定完成後，即可依需求設定 RAID 模式，請參考「RAID 設定 /F. 切換 RAID 設定的標準程序」，做 RAID 模式切換設定。

5. RAID 設定

- A. 若使用的硬碟之前有在其他機器作過 RAID，請先確認 RAID 已清除並重新格式化完畢。
- B. 切換任何 RAID 模式之前，請先行確認所有資料的備份在其他硬碟上。
- C. JBOD (出廠預設值)：各別使用置入的硬碟存取空間。
- D. RAID-1：兩顆硬碟進行同步寫入達到備份效果，其中一顆硬碟損壞仍可繼續運作，將損壞硬碟更換新硬碟後將會自動進行資料重建；當裝入的硬碟為 1 大 1 小時，GR3660-TB3 會將大容量的硬碟當成小容量的硬碟。
- E. RAID-0：僅加速資料存取速度，對於資料備份不作任何保障。
- F. 切換 RAID 設定的標準程序：
- 步驟 1：請在 GR3660-TB3 連線到電腦後，一併打開電腦和 GR3660-TB3 的電源開關。
- 步驟 2：請在藍燈恆亮時，將在 GR3660-TB3 背板上設定 RAID 設定的「切換開關」調到你所要的設定位置。
- 步驟 3：請使用頂針插入「重置鍵」，待前面板抽取盒上的閃爍藍紫燈結束、並轉成恆亮藍燈後鬆開頂針。
- 步驟 4：請您再做一次關、開 GR3660-TB3 電源的動作後，您已經改變、並重新設定了 GR3660-TB3 的 RAID。

刪除或改變 RAID 設定的警告：

若您要刪除或改變任何 RAID 的設定，請先行備份硬碟內的所有資料，RAID 一旦刪除或改變亦即代表資料已經被刪除。

6. 硬碟狀態指示燈號說明

狀態	硬碟狀態燈
無硬碟	紅燈恆亮
硬碟故障	紅燈恆亮
硬碟閒置	藍燈恆亮
資料存取	藍燈閃爍
資料重建 - 來源碟	呼吸燈 (藍燈)
資料重建 - 目標碟	呼吸燈 (紫燈)

7. 與其他裝置連接說明

1. TB port : Thunderbolt™ 3 連接埠可串接 TB3、USB 3.1 和 DisplayPort 裝置；其中向下支援 USB3.0/USB2.0。有轉接線即可連接不同規格之 USB 產品。本產品支援 TB port 供電功能 (PD)，可以提供 15W (5V/3A) 的電源輸出給支援 5V/3A 充電的筆記型電腦使用，不用額外連接電源。
2. Mini Display port : 配置 Mini DisplayPort (mDP) 連接埠，支援額外的螢幕輸出。

裝置連接示意圖：

- A. GR3660-TB3: TB A port 接 MB (Host) · TB B port 接 other Device (USB or TB) · mDP 接螢幕。

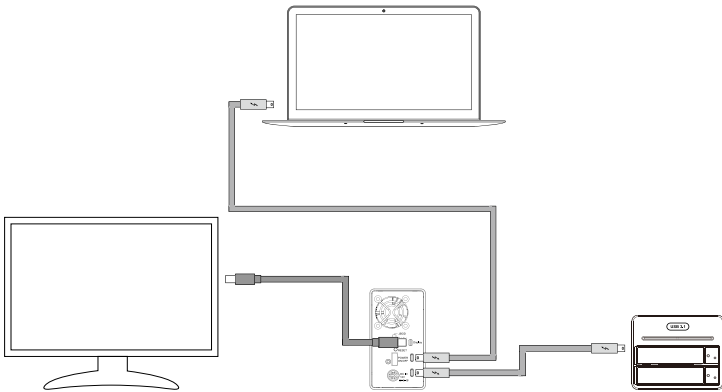

- B. GR3660-TB3: TB A port 接 MB (Host), TB B port 接螢幕, mDP 接螢幕 (雙螢幕)

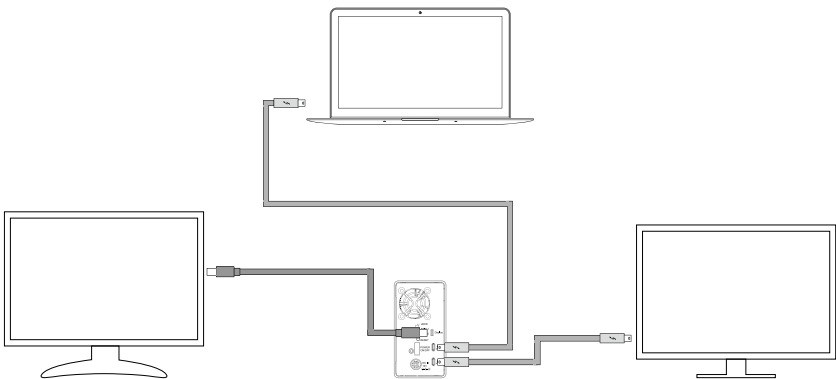

8. 常見問題

1. GR3660-TB3 在開機情況下，未連接 Thunderbolt™ cable 時，風扇與電源指示燈皆為停止及休眠狀態，直至連接 Thunderbolt™ cable 至電腦才會啟動風扇及電源指示燈。
2. 電腦進入睡眠模式時，GR3660-TB3 的風扇與電源指示燈皆為停止及休眠狀態，直至喚醒時才會啟動風扇及電源指示燈。
3. 若硬碟已在其他磁碟陣列產品存取資料或設定 RAID MODE 過，建議還原成 JBOD 模式後再應用於 GR3660-TB3，以避免產生無法讀取硬碟問題。
4. 如電腦無法辨識此系統，請前往 - 產品資料下載頁面 (<http://www.raidon.com.tw/RAIDON2016/download.php>) 下載驅動程式並安裝。
5. 若 GR3660-TB3 裝設在 Windows 作業系統上卻無法連線，請參考下方步驟：
 - A. 開啟右下角工作列圖示
 - B. 在 Thunderbolt™ software 圖示上擊點滑鼠右鍵
 - C. 選擇「批准已接上的裝置」
 - D. 選擇連接埠
 - E. 等候對話框「批准 Thunderbolt™ 裝置」出現
 - F. 選擇「永遠連接」
 - G. 按下確定。

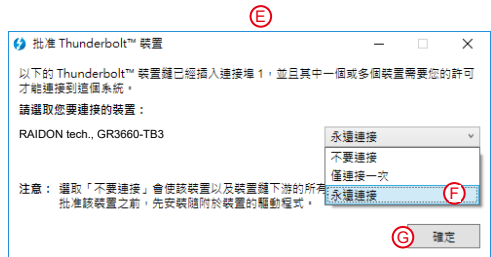

6. 礙於 macOS 10.13 (High Sierra) 的權限設定，如果程式來自於未識別開發者，是無法直接安裝的。請依照下列步驟進行安裝。
- 執行 `MarvellMvumi.pkg`，出現來自未識別開發者的警訊，先點選右下角的「好」。
 - 進入「系統偏好設定」後，點選「安全性與隱私」功能。
 - 接著下方就會看到被阻擋的訊息，按旁邊的「允許」。

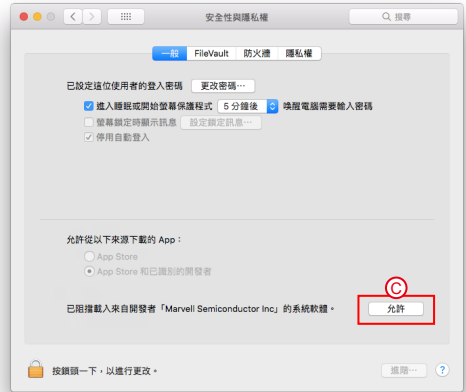
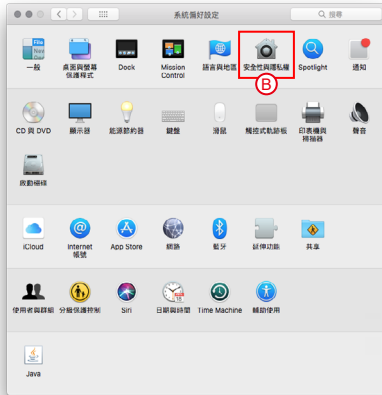

注意：如果無法擊點允許按鈕，請先擊點左下角的鎖頭圖示，並輸入管理員密碼。

RAIDON

www.raidon.com.tw

